

16 - ANCHOR LOCATIONS

TOP VIEW

SIDE VIEW

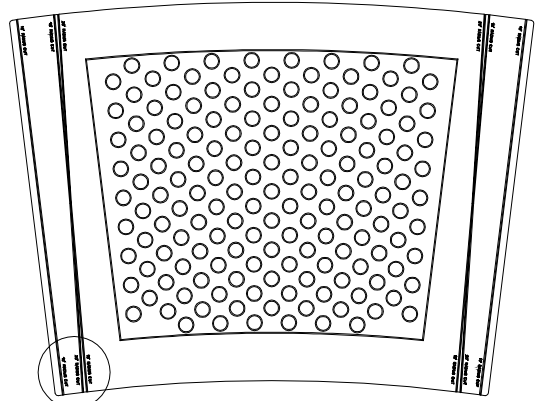

BOTTOM VIEW

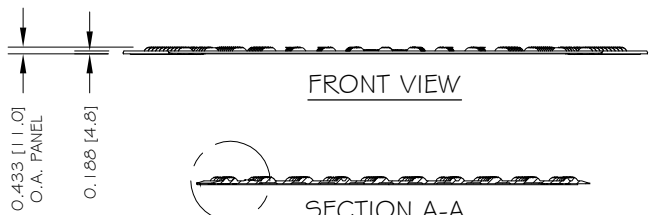

FRONT VIEW



SECTION A-A

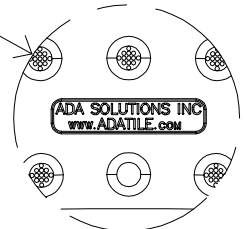

LABELED RADIUS CUT LINES

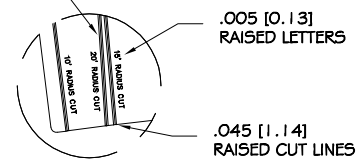

DETAIL C

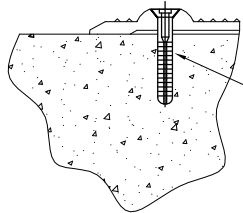

SECTION B-B
PANEL INSTALLATION

COMPOSITE SLEEVE ANCHOR
1/6" TOTAL PER PANEL

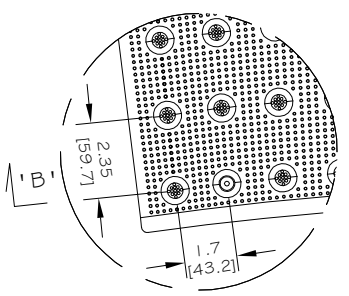

DETAIL A

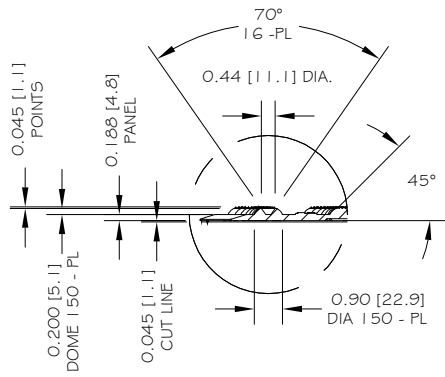

DETAIL B

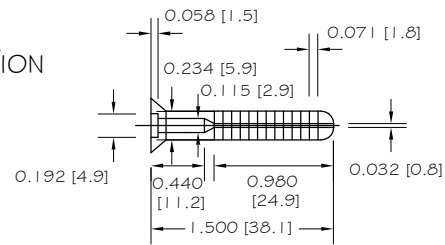

COMPOSITE SLEEVE ANCHOR
WITH STAINLESS STEEL NAIL
1/4" X 1 1/2" (6.35mm x 38.1mm)

Curb Radius	'A' Dimension	'B' Dimension
10'	2' - 8 ⁵ / ₁₆ "	2' - 2 ⁷ / ₁₆ "
15'	2' - 3 ⁵ / ₈ "	1' - 11 ⁷ / ₁₆ "
20'	2' - 3 ¹ / ₁₆ "	1' - 11 ¹⁵ / ₁₆ "

IMPERIAL UNIT CHART

Curb Radius (m)	'A' Dimension (mm)	'B' Dimension (mm)
3.05	821	671
4.57	702	595
6.10	687	608

METRIC UNIT CHART

ALL DIMENSIONS NOMINAL
PRIMARY DIMENSION INCHES
mm IN PARENTHESES

U.S. PATENT #9,365,984

TRADE TACTILE WARNING SURFACE	PART NO. 24RADRET_
MATERIAL SMC COMPOSITE	

PROJECT

SURFACE APPLIED TACTILE
WARNING SURFACE PANEL
16-ANCHOR LOCATIONS
2.350" (59.7mm) IN LINE TRUNCATED DOME
PART SIZE 24" (610mm) x 10' (3.05m),
15' (4.57m), 20' (6.10m) RADIAL
PLANS AND DETAILS

DRAWING NO. ADA-SA24RAD	DATE 06-16-17
----------------------------	------------------



WWW.ADATILE.COM
PHONE: (800)372-0519
EMAIL: INFO@ADATILE.COM