

TOP OF PANEL

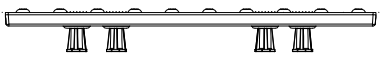

ELEVATION

DETAIL B

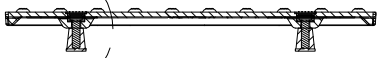

SECTION A-A

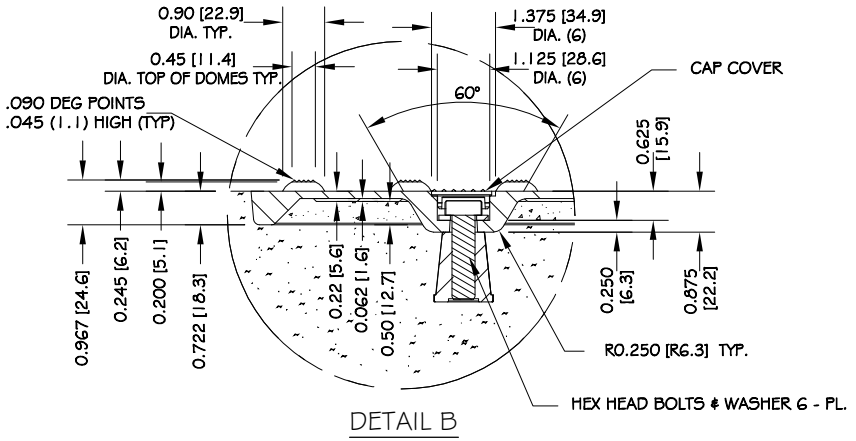

DETAIL B

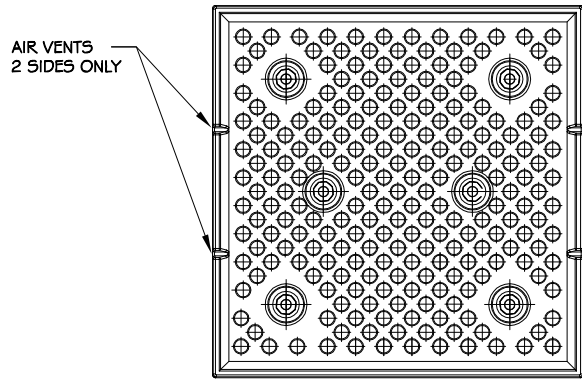
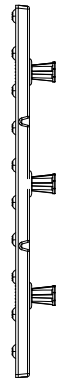

BOTTOM OF PANEL

AIR VENTS
2 SIDES ONLY

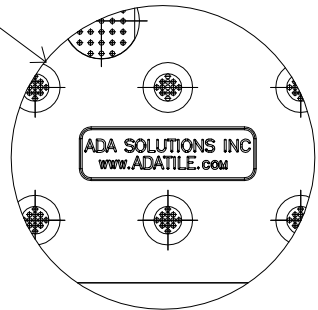

.090 DEG POINTS
.045 (1.1) HIGH (TYP)
SPACED AT 0.2 (5.1)

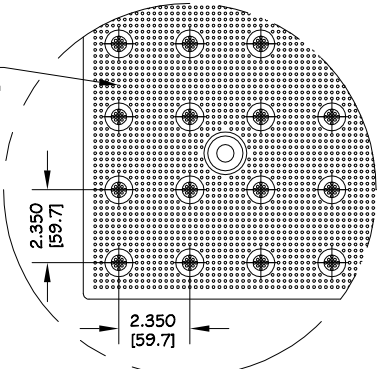

DETAIL A
FIELD DOT 7 DOME LAYOUT

ALL DIMENSIONS NOMINAL PRIMARY DIMENSION INCHES mm IN PARENTHESES	
TRADE TACTILE WARNING SURFACE	PART NO. 2424NV6REP_
MATERIAL SMC COMPOSITE	
PROJECT WET SET ADA REPLACEABLE TACTILE WARNING SURFACE UNIT 6-BOLT LOCATIONS 2.35" (59.7mm) IN LINE TRUNCATED DOME PART SIZE 24" (610mm) x 24" (610mm) PLANS AND DETAILS	
DRAWING NO. ADA-REP2424	DATE 03-08-17
 ADA SOLUTIONS, INC. DETECTABLE WARNING SURFACES FOR PEDESTRIAN CROSSINGS WWW.ADATILE.COM PHONE: (800)372-0519 EMAIL: INFO@ADATILE.COM	